

Wireless Non Programmable Thermostat RFRA

Button / Symbol Description



Setting the Temperature

Rotate the handwheel clockwise to turn up the temperature.
Rotate the handwheel anti-clockwise to turn down the temperature.

On / Off function

By pressing the On / Off button, this turns the thermostat on and off.

Contents

1. Specifications & wiring
2. Mounting
3. Installation
4. Button / LED description
5. Resetting the RF1 receiver
6. To connect the RF1 receiver to a RFRA wireless thermostat
7. To disconnect the RFRA thermostat from a RF1 receiver



Important: Keep this document

Prior to operation, it is necessary to complete all required settings described in this section.

CAUTION!

Before commencing any work on the electrical connections, you must first disconnect the device from the mains. None of the 230V connections must be live until the installation has been completed and the housing is closed. Only qualified electricians or authorised service staff are permitted to open the terminal box.

There are parts that carry mains voltage behind the cover. The terminal box must not be left unsupervised when open. (Prevent non specialists and especially children from gaining access to it.)

Ensure that this wireless enabled receiver is installed 1 metre from any metallic object, television, radio or wireless internet transmitter.



1. Specifications & wiring

Power Supply: 230 Vac 50Hz
 Contact Rating: 250 Vac 10(3)A
 Ambient Temp: 0~50°C

Class II appliance 
 Pollution degree 2: Resistance to voltage surge 2500V; as per EN 60730

Internal wiring diagram for RF1

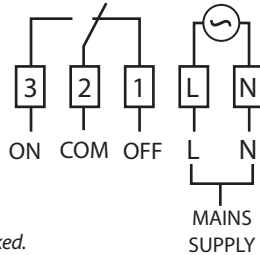

*If mains voltage output is required, terminals L & 2 must be electrically linked.

2. Mounting

The RF1 receiver should be wall mounted in an area within 20 metres distance of the wireless thermostat.

It is important that the receiver is mounted more than 1 metre away from metal objects as this will affect communication with the thermostat.

The receiver should also be installed at least 1 metre from any electronic devices such as radio, TV, microwave or wireless network adaptor.

- The unit can be fitted to:
1. Recessed conduit boxes
 2. Surface mounting boxes

3. Installation

Slacken the fastening screw on the bottom of the receiver with a philips screwdriver.

The receiver is hinged and can be opened 180 degrees. Mount the unit as described in section 2. Wire the unit as described in section 1. Close the receiver and tighten the fastening screw.

4. Button / symbol description



4. Button / LED description (Continued)

Wireless connect: Once voltage has been applied this button may be pressed to initialise the pairing process with the wireless thermostat. Once pressed the red LED will begin to flash.

Manual override: This button will manually override the system.

Wireless connect indicator: This LED will flash on receiving wireless signals. If it is constantly ON, the RF1 receiver has been disconnected from the wireless thermostat.

5. Resetting the RF1 receiver

Press the  RESET button located on the side of the receiver. Within 2 seconds, press the connect button. The RF1 receiver is now reset.

6. To connect the RF1 receiver to a RFRA thermostat

The wireless connect LED will be constant red once power has been applied.

Press the  button **on the RF1 receiver**.

Both the red and green LED on the RF1 will begin to flash.

On the RFRA thermostat, press the  button on the bottom of the thermostat, the front housing will detach from the baseplate.

Press the CODE button on the printed circuit board.

When r1 appears on the screen, press the hand wheel once.

The thermostat is now connected to the RF1 receiver.

7. To disconnect the RFRA thermostat from a RF1 receiver

On the RF1 receiver

Press the reset button on the right side of the housing.

Within 2 seconds, press the connect button.

The RF1 receiver is now disconnected from the RFRA thermostat.

On the RFRA thermostat

Press the  button on the bottom of the thermostat, the front housing will detach from the baseplate.

Press the RESET button on the printed circuit board. "NO" will flash on the screen.

Rotate the hand wheel clockwise until "YES" appears on the screen.

Press the hand wheel once to confirm the setting.

The thermostat is now disconnected to the receiver.



CAUTION! Installation and connection should only be carried out by a qualified person and in accordance with national wiring regulations.

- If this device is used in a way not specified by the manufacturer, its safety may be impaired.
- Ensure that this wireless enabled thermostat is installed 1 metre from any metallic object, television, radio or wireless internet transmitter.

This thermostat can be mounted in the following ways:

- To a recessed conduit box
- To a surface mounted box
- Directly mounted on wall
- Table mounted with accessory provided.

Important: Keep this document



1

CE
Type 1C EN60730
IP20 EN60529
50 °C / 122 °F
0 °C / 32 °F
5-95%RH
B06484

2

3

Press to open

4

5

6

Mounting clips
Stand

Contents

1. Factory default settings
2. Specification & wiring
3. Mounting
4. Installation
5. Button / symbol description
6. Resetting the thermostat
7. On / Off function
8. Lock function
9. To connect the RFRA thermostat to the RF1 receiver
10. To disconnect the RFRA thermostat from the RF1 receiver



Important: Keep this document

Prior to setting the thermostat, it is necessary to complete all required settings described in this section.



CAUTION!

Only qualified electricians or authorised service staff are permitted to open the thermostat.

Ensure that this wireless enabled thermostat is installed 1 metre from any metallic object, television, radio or wireless internet transmitter.

1. Factory default settings



Temperature indicator:	°C
Switching differential:	0.2°C
In built frost protection:	5°C
Keypad lock:	Off

2. Specifications & wiring

Power Supply:	2 x AAA Alkaline Battery
Power consumption:	50 uA
Battery replacement:	Once per year
Temp. Control Range:	5...35°C
Dimensions:	84 * 84 * 30mm
Temp. sensor:	NTC 10K Ohm @ 25°C
Temp. indication:	°C

3. Mounting

The mounting height should be 1.5 meters above the floor level. The thermostat should be wall mounted in the room where the heating is to be controlled.

The place of installation should be chosen so that the sensor can measure the room temperature as accurately as possible.

Choose the mounting location to prevent direct exposure to sunlight or other heating / cooling sources when mounted.

- The unit can be fitted to:
1. Recessed conduit boxes
 2. Surface mounting boxes
 3. Directly on walls
 4. Table mounting with stand provided

4. Installation

- Press the button on the bottom of the thermostat.
- The front housing will detach from the baseplate.
- Insert the batteries (provided) into the thermostat.
- Mount the unit as described in section 3.
- Offer the baseplate up to the thermostat. Snap it into position to close.

5. Button / symbol description

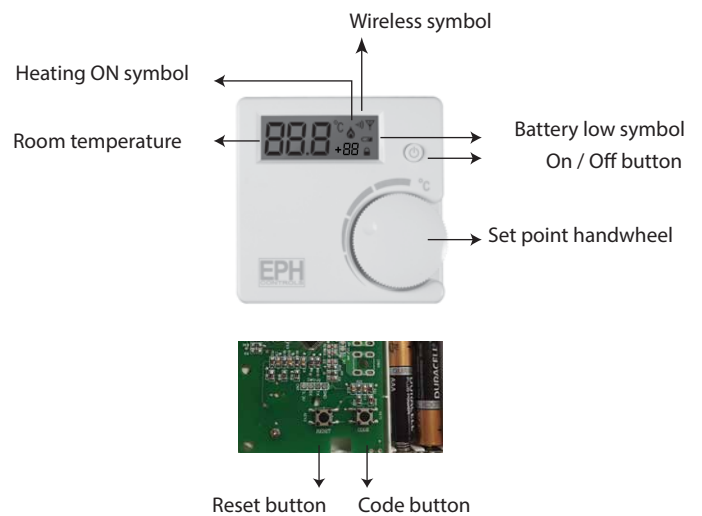

6. Resetting the thermostat

- Press the button on the bottom of the thermostat, the front housing will detach from the baseplate.
- Insert the batteries into the thermostat.
- Press the reset button on the PCB, 'NO' will flash on the screen.
- Rotate the hand wheel clockwise until 'YES' appears on the screen.
- Press the hand wheel once to confirm the setting.
- The thermostat has now been reset and the current temperature will appear on the screen.

7. On / Off function

By pressing the On / Off button, this turns the thermostat on and off.

8. Lock function

- To lock the thermostat, press the hand wheel for 10 seconds.
- symbol will appear on the screen.
- To unlock the thermostat, press the hand wheel for 10 seconds.
- symbol will disappear from the screen.

9. To connect the RFRA thermostat to the RF1 receiver

On the front of the RF1 receiver

Press the connect button. The "System On" green LED will begin to flash.

On the RFRA thermostat

Press the  button on the bottom of the thermostat, the front housing will detach from the baseplate.

Press the CODE button on the printed circuit board.

When r1 appears on the screen, press the hand wheel once.

The thermostat is now connected to the receiver.

10. To disconnect the RFRA thermostat from the RF1 receiver

On the RF1 receiver

Press the reset button on the right side of the housing.

Within 2 seconds, press the connect button.

The RF1 receiver is now disconnected from the RFRA thermostat.

On the RFRA thermostat

Press the  button on the bottom of the thermostat, the front housing will detach from the baseplate.

Press the RESET button on the printed circuit board.

"NO" will flash on the screen.

Rotate the hand wheel clockwise until "YES" appears on the screen.

Press the hand wheel once to confirm the setting.

The thermostat is now disconnected from the receiver.